

**NEW** PRODUCT!

# Super-LED<sup>®</sup> 600/700/900 Series

CERTIFIED LINEAR DIRECTIONAL LIGHTHEADS

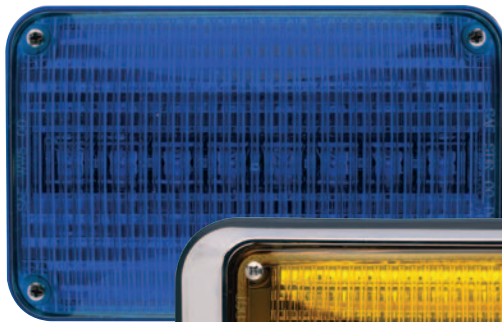

600 Series

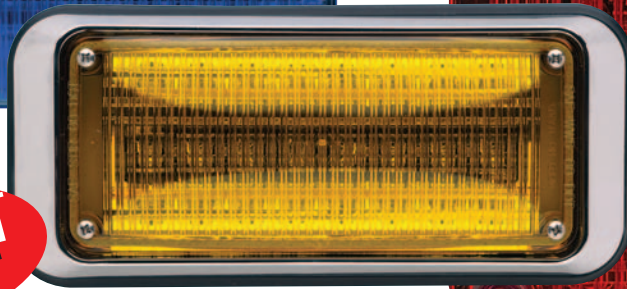

700 Series (shown with optional flange)

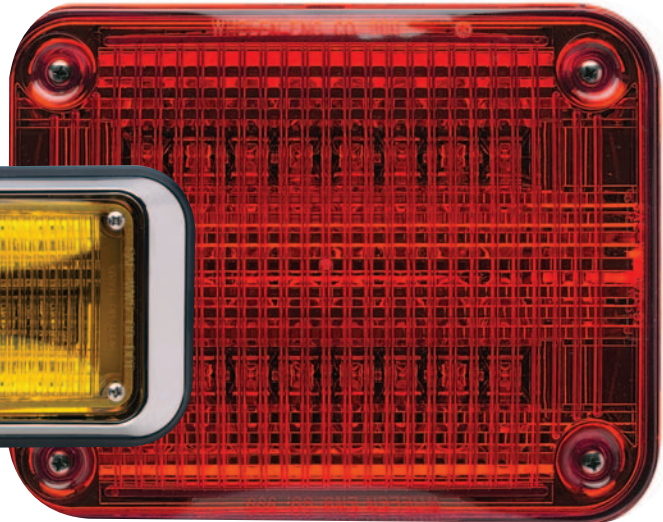

900 Series



**Super-LED Linear lightheads feature new, patent-pending optics designed to provide greater light output that rivals strobe in intensity.**

Surface mounted lightheads are vibration, moisture and corrosion resistant for long-life, heavy-duty performance and retrofit existing lightheads. Now you can choose certified, legal lighting for fire service or emergency vehicles needing to meet critical specifications.

## FEATURES

- Patent pending optics outperform any other similar directional lighthead on the market today.
- Super-LED design features heavy-duty performance, vibration, moisture and corrosion resistance.
- Color outer lens over color LEDs.
- Steady-Burn models require a LED flasher, purchased separately.



Available in Red, Amber and Blue

Form# LIN0804

- 600 Series and 700 Series each feature a single row of Linear8 Super-LEDs.
- 700 Series mounts directly on the vehicle with or without flange.
- 900 Series is available in a single or double row of Linear LEDs.
- Split Linear-LED models are available. 600/700 are side by side and 900 is over and under.
- All lightheads furnished with 6" wire pigtail.
- Optional ABS chrome-plated flange is available for all lightheads.
- Ideal for applications requiring NFPA, SAE J595, SAE 2498, California Title 13 or KKK-A-1822E certifications.
- All models are 12.8 VDC and the 600/700 Series draws under 1 amp average while the 900 Series draws under 2 amps average.
- Five year HDP<sup>®</sup> Heavy-Duty Professional warranty.

## MODELS: Steady Burn

Steady burn models require a remote flasher, such as Model ULF28 purchased separately.

- 90\*\*5S\*R: 900 Series.
- 70\*02S\*R: 700 Series.
- 60\*02S\*R: 600 Series.

## MODELS: Flashing



Flashing models include 13 Scan-Lock<sup>™</sup> flash patterns plus steady burn and low power control, an industry first. There is no need to add a centralized flasher(s) when using these lightheads.

- 90\*\*5F\*R: 900 Series.
- 70\*02F\*R: 700 Series.
- 60\*02F\*R: 600 Series.

## OPTIONS

- 90FLANGC:** Chrome plated flange for 900 Super-LED Series only.
- 7FLANGEB:** Black flange for 700 Series.
- 7EFLANGE:** Chrome plated flange for 700 Series.
- 6FLANGEB:** Black flange for 600 Series.
- 6EFLANGE:** Chrome plated flange for 600 Series.

\* Replace asterisk in model number with desired color. A=Amber, B=Blue, R=Red



All Whelen Products are proudly made in the U.S.A

**WHELEN<sup>®</sup>**  
Engineers for the Emergency Warning Industry

Super-LED<sup>®</sup> 600/700/900 Series Lightheads

# Super-LED® 600/700/900 Series Lightheads

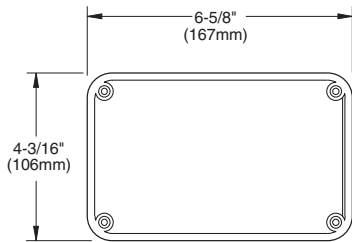

600 Series

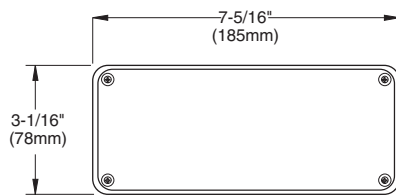

700 Series

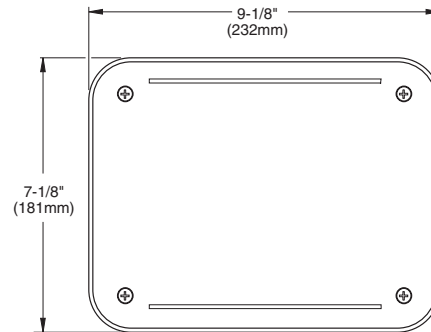

900 Series

## Lighting Certifications

MODEL	RED	AMBER	BLUE
900	J595 Title 13 Table 1 Class B KKK-A-1822E Upper J845 Class 1 110° Arc	J595 Title 13 Table 1 Class B KKK-A-1822E Upper J845 Class 1 100° Arc	J845 Title 13 Table 1 Class B J845 Class 1 50° Arc
700	J595 Title 13 Table 1 Class B KKK-A-1822E Upper J845 Class 1 90° Arc	J595 Title 13 Table 1 Class B J845 Class 1 30° Arc	Title 13 Table 1 Class B J845 Class 1 20° Arc
600	J595 Title 13 Table 1 Class B KKK-A-1822E Upper J845 Class 1 50° Arc	J595 Title 13 Table 1 Class B J845 Class 1 40° Arc	Title 13 Table 1 Class B J845 Class 1 20° Arc

For complete current lighthead certification, contact factory.

## Flasher recommended for Steady Burn Models (purchased separately)

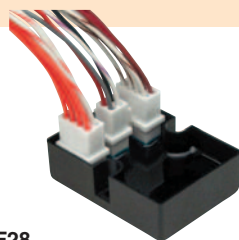

ULF28

Eight-outlet, two channel LED flasher with 5 Scan-Lock™ flash patterns, four patterns have Phase 1 and Phase 2 for alternate or simultaneously flashing LED lightheads. 10 amps maximum, 5 amps per channel, 1.25 amps per outlet.

## Flash Patterns for Flashing Models

SignalAlert™ 75  
SignalAlert 150  
SingleFlash 375  
SingleFlash 150  
SingleFlash 75  
DoubleFlash 150  
DoubleFlash 75  
CometFlash® 75  
ActionFlash™  
ModuFlash™  
ComAlert™  
ActionScan™  
SignalAlert Steady  
SteadyBurn (Brake)

## Split Linear-LED Models

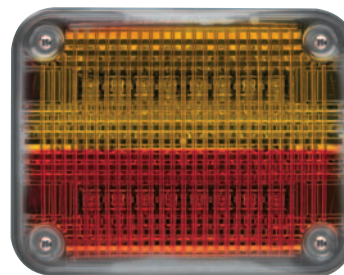

90RAUFRCR



70RBSFCR

70RCSFCR

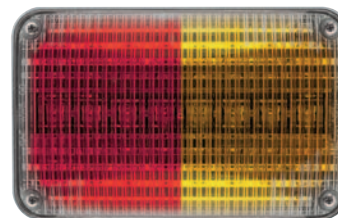
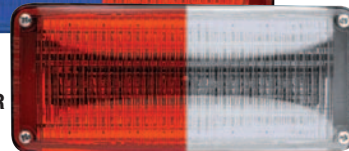

60RA6FCR



Route 145, Winthrop Road  
Chester, Connecticut 06412-0684  
(860) 526-9504 • Fax: (860) 526-4078  
Internet: www.whelen.com



Whelen Engineering reserves the right to upgrade and improve products without notice.